

SAFETYRESPECT®

MOUNTING INSTRUCTIONS EDGE PROTECTION SYSTEMS

MONTERINGSANVISNING FALLSKYDDSSYSTEM
MONTASJEANVISNING FALLSIKRINGSSYSTEM
MONTERINGSANVISNING FALDSIKRINGSSYSTEM
PUTOAMISSUOJAUKSEN ASENNUSOHJE
KRAŠTŲ APSAUGOS SISTEMŲ MONTAVIMO INSTRUKCIJOS
INSTRUCTIONS DE MONTAGE SYSTÈME DE SÉCURITÉ ANTICHUTE
INSTRUCCIONES DE MONTAJE SISTEMAS ANTICAÍDAS
KENAR KORUMA SISTEMLERİ MONTAJ TALIMATNAMESİ
ИНСТРУКЦИЯ ПО МОНТАЖУ ЗАЩИТНОЙ СИСТЕМЫ ОТ ПАДЕНИЙ
ةفاحلا ةيامحل اقمظنأ بيكرت تاميلعت



ART NO 911110, 913111, 913121

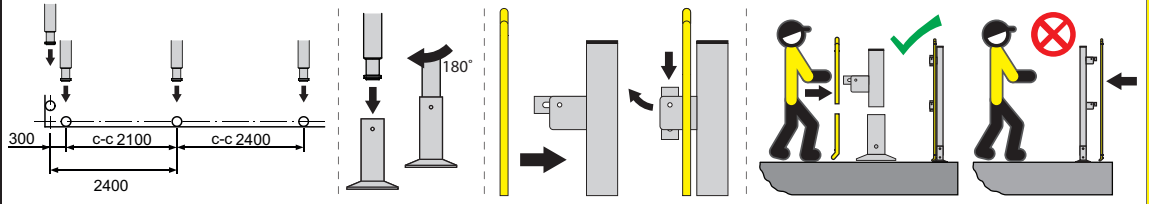
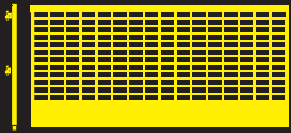

ART NO 912110

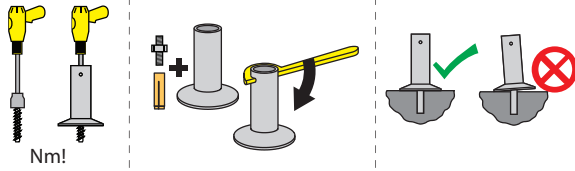

ART NO 912116

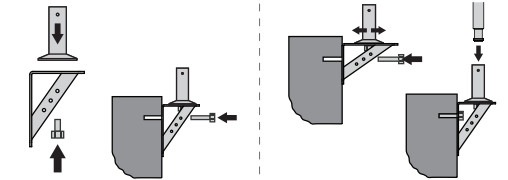

ART NO 912111

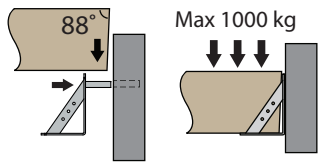

ART NO 912116

ART NO 912118

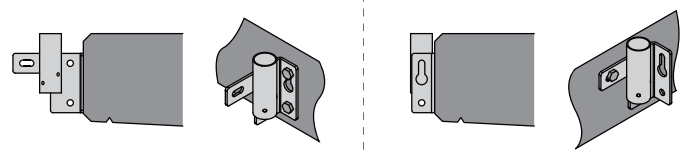

ART NO 919010

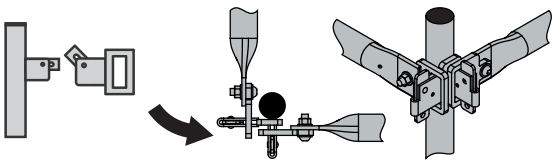

ART NO 912121

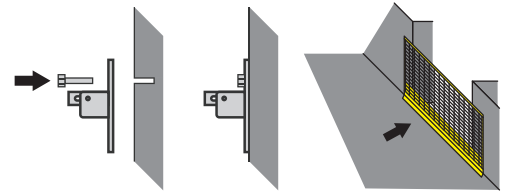

ART NO 913310, 913311, 913312

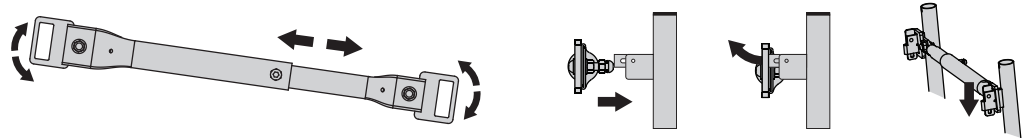
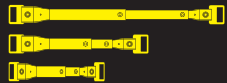

ART NO 919015, 919016

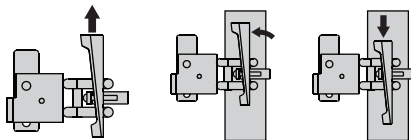
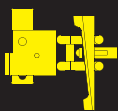

ART NO 912320

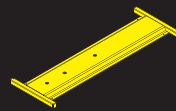

ART NO 912220

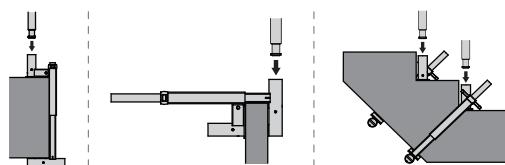

ART NO 912209

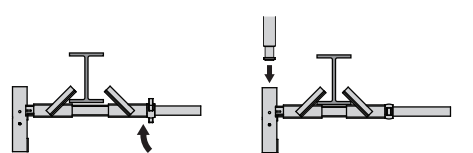

ART NO 912245

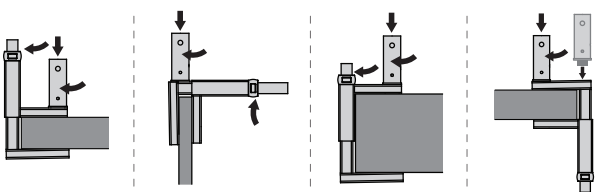

ART NO 912119

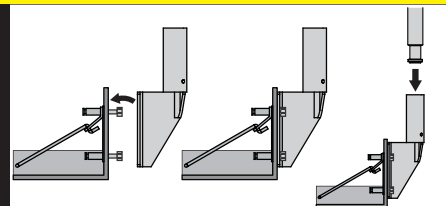

ART NO 912310, 912320

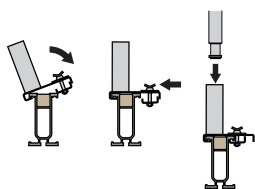

ART NO 912168, 912169

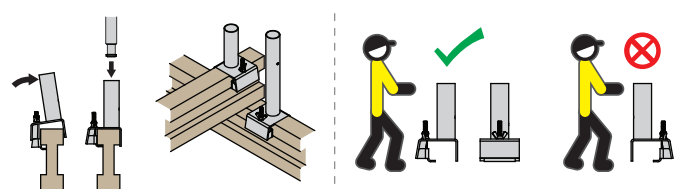

ART NO 914122

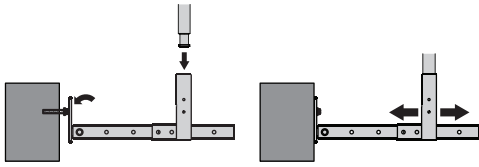

ART NO 914124

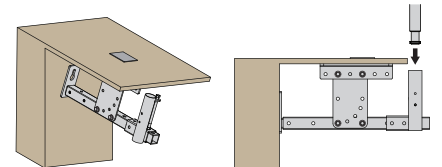

ART NO 981122

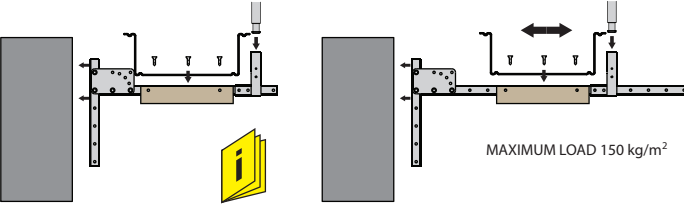

MAXIMUM LOAD 150 kg/m²

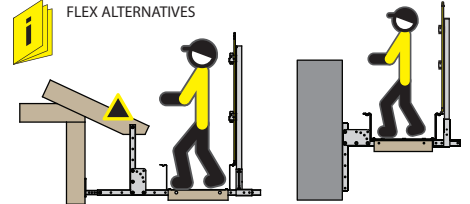

ART NO 914123

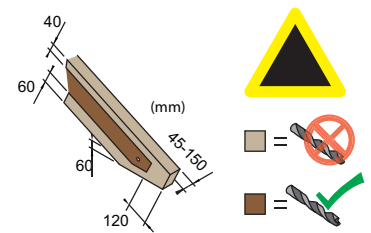
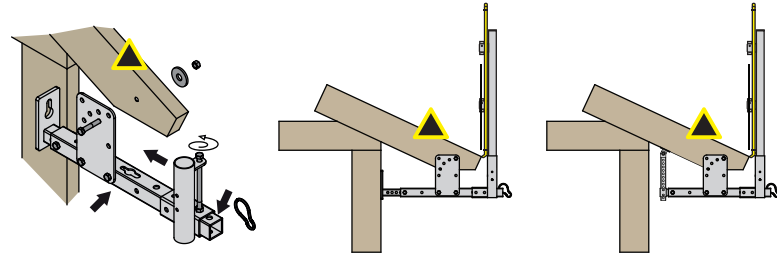
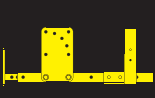

ART NO 911107, 911108

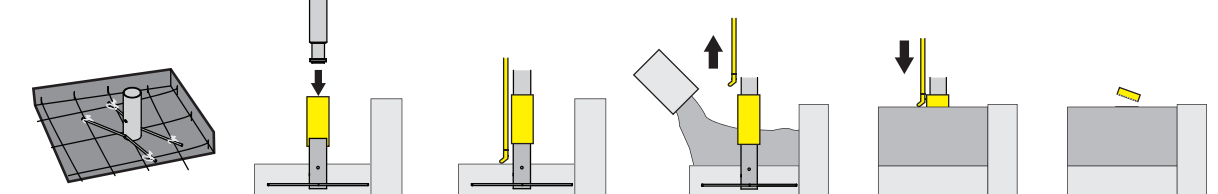
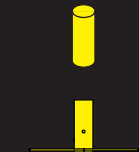

ART NO 914009

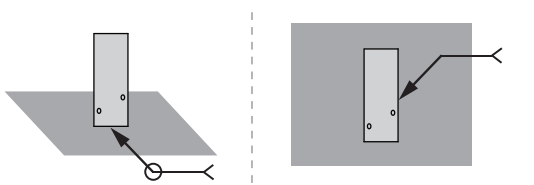

ART NO 911109

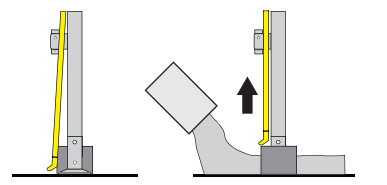

ART NO 930803

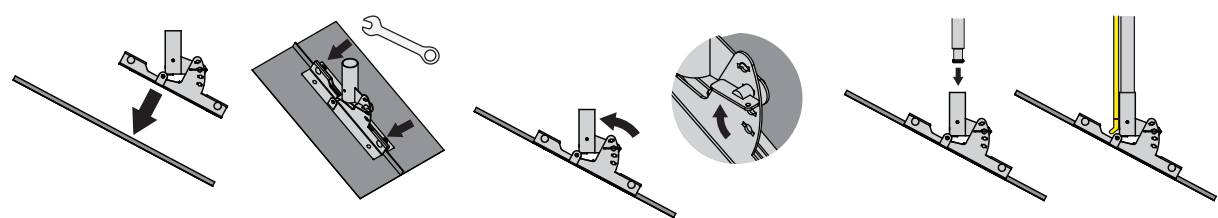
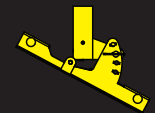

ART NO 981120, 981111, 981109, 981130

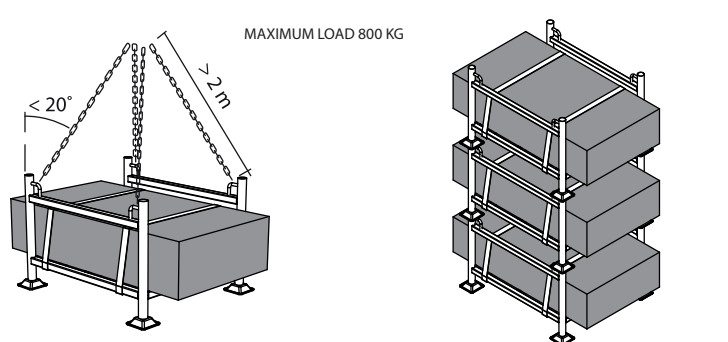
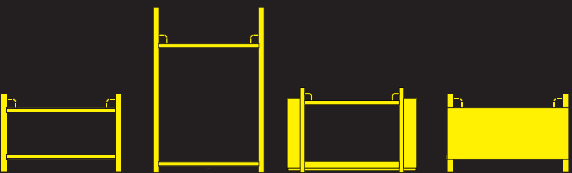

MAXIMUM LOAD 800 KG

